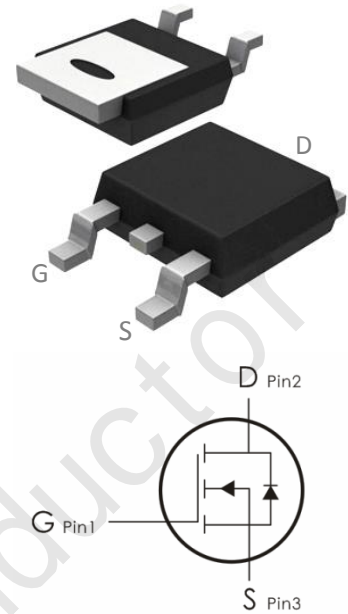


## Description:

This N-Channel MOSFET uses advanced trench technology and design to provide excellent  $R_{DS(on)}$  with low gate charge. It can be used in a wide variety of applications.



## Features:

- 1)  $V_{DS}=100V, I_D=15A, R_{DS(ON)} < 100 m\Omega @ V_{GS}=10V$
- 2) Low gate charge.
- 3) Green device available.
- 4) Advanced high cell density trench technology for ultra  $R_{DS(ON)}$ .
- 5) Excellent package for good heat dissipation.

## Absolute Maximum Ratings: ( $T_C=25^\circ C$ unless otherwise noted)

Symbol	Parameter	Ratings	Units
$V_{DS}$	Drain-Source Voltage	100	V
$V_{GS}$	Gate-Source Voltage	$\pm 20$	V
$I_D$	Continuous Drain Current- $T_C=25^\circ C$	15	A
	Continuous Drain Current- $T_C=70^\circ C$	12	
	Pulsed Drain Current <sup>1</sup>	60	
$E_{AS}$	Single Pulse Avalanche Energy	16	mJ
$P_D$	Power Dissipation, $T_C=25^\circ C$	50	W
$T_J, T_{STG}$	Operating and Storage Junction Temperature Range	-55 to +150	$^\circ C$

## Thermal Characteristics:

Symbol	Parameter	Max	Units
$R_{\theta JC}$	Thermal Resistance, Junction to Case	3	$^\circ C/W$
$R_{\theta JA}$	Thermal Resistance, Junction to Ambient	---	

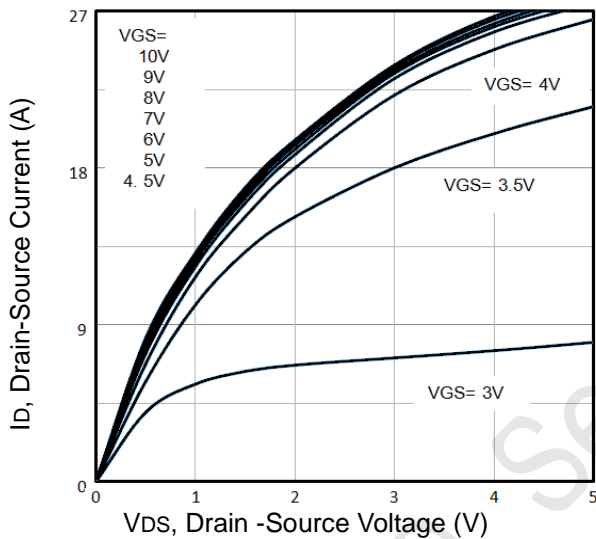
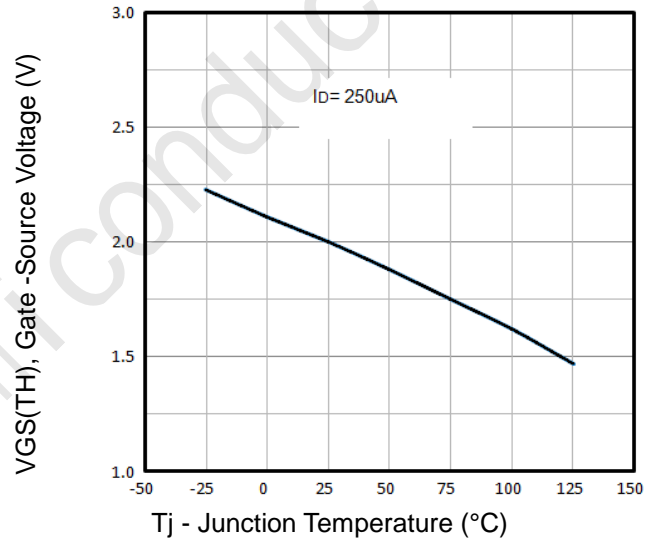
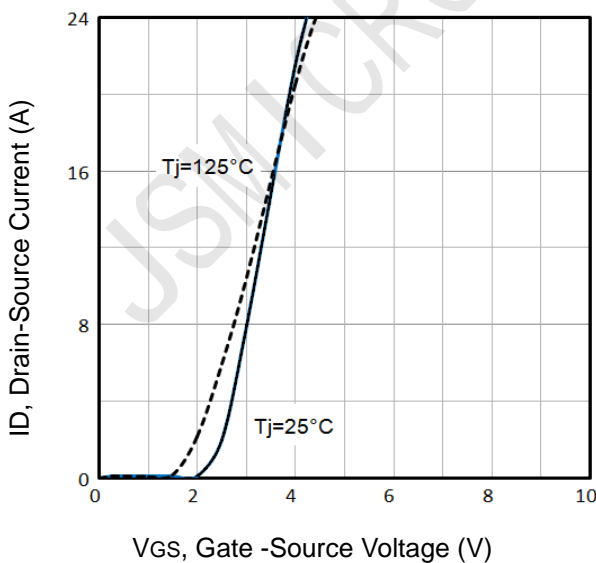
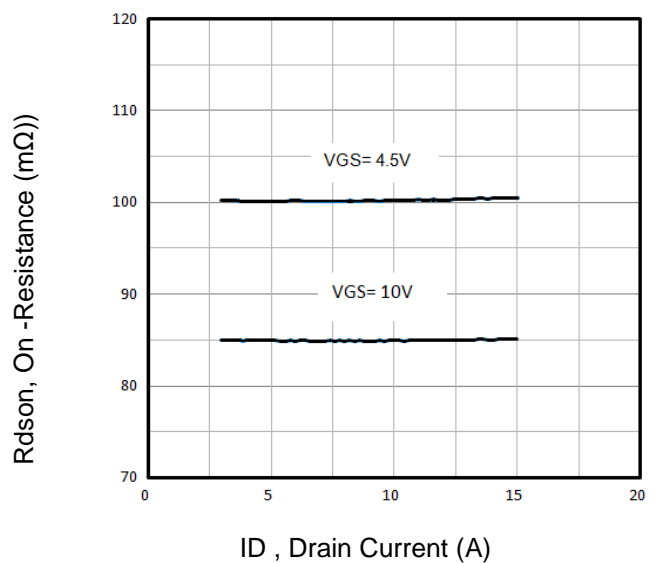
**Electrical Characteristics:** ( $T_c=25^\circ\text{C}$  unless otherwise noted)

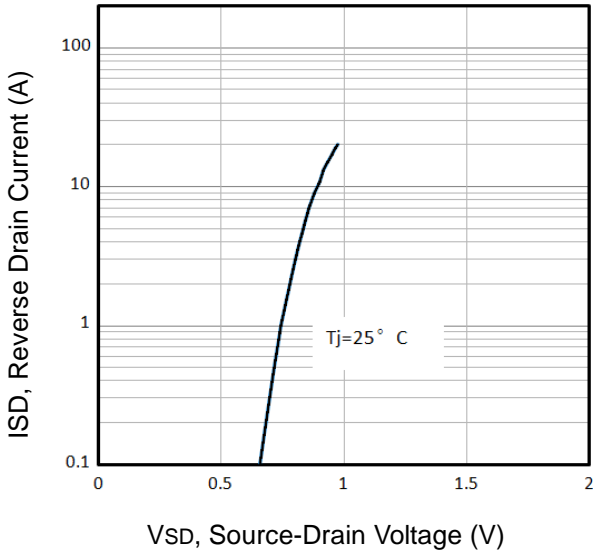
Symbol	Parameter	Conditions	Min	Typ	Max	Units
<b>Off Characteristics</b>						
$BV_{DSS}$	Drain-Source Breakdown Voltage	$V_{GS}=0V, I_D=250\ \mu\text{A}$	100	---	---	V
$I_{DSS}$	Zero Gate Voltage Drain Current	$V_{GS}=0V, V_{DS}=80V$	---	---	1	$\mu\text{A}$
$I_{GSS}$	Gate-Source Leakage Current	$V_{GS}=\pm 20V, V_{DS}=0A$	---	---	$\pm 100$	nA
<b>On Characteristics</b>						
$V_{GS(th)}$	GATE-Source Threshold Voltage	$V_{GS}=V_{DS}, I_D=250\ \mu\text{A}$	1	2	3	V
$R_{DS(ON)}$	Drain-Source On Resistance <sup>3</sup>	$V_{GS}=10V, I_D=10A$	---	75	100	m $\Omega$
		$V_{GS}=4.5V, I_D=8A$	---	100	115	
$G_{FS}$	Forward Transconductance	$V_{DS}=0V, I_D=0A$	---	---	---	S
<b>Dynamic Characteristics</b>						
$C_{iss}$	Input Capacitance	$V_{DS}=25V, V_{GS}=0V, f=1\text{MHz}$	---	890	---	pF
$C_{oss}$	Output Capacitance		---	60	---	
$C_{rss}$	Reverse Transfer Capacitance		---	25	---	
<b>Switching Characteristics</b>						
$t_{d(on)}$	Turn-On Delay Time <sup>3</sup>	$V_{DD}=25V, I_D=8A,$ $V_{GS}=10V, R_{GEN}=1\Omega$	---	14.2	---	ns
$t_r$	Rise Time <sup>2,3</sup>		---	34	---	ns
$t_{d(off)}$	Turn-Off Delay Time		---	40.4	---	ns
$t_f$	Fall Time <sup>2,3</sup>		---	6	---	ns
$Q_g$	Total Gate Charge <sup>3</sup>		$V_{GS}=10V, V_{DS}=80V,$ $I_D=10A$	---	24	---
$Q_{gs}$	Gate-Source Charge	---		5	---	nC
$Q_{gd}$	Gate-Drain "Miller" Charge	---		8	---	nC
<b>Drain-Source Diode Characteristics</b>						
$V_{SD}$	Source-Drain Diode Forward Voltage <sup>3</sup>	$V_{GS}=0V, I_S=8A$	---	0.8	1.2	V

<b>Trr</b>	Reverse Recovery Time	ISD=8A, VGS=0V di/dt=100A/μs	---	35	---	Ns
<b>qrr</b>	Reverse Recovery Charge		---	121	---	nc

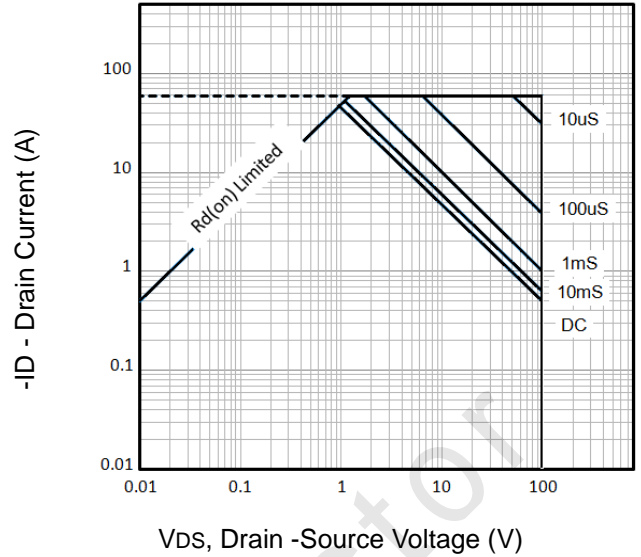
**Notes:**

- ① Pulse width limited by maximum allowable junction temperature
- ② Limited by TJmax, starting TJ = 25°C, L = 0.1mH, RG = 25Ω, IAS = 18A, VGS = 10V. Part not recommended for use above this value
- ③ Pulse width ≤ 300μs; duty cycle ≤ 2%.

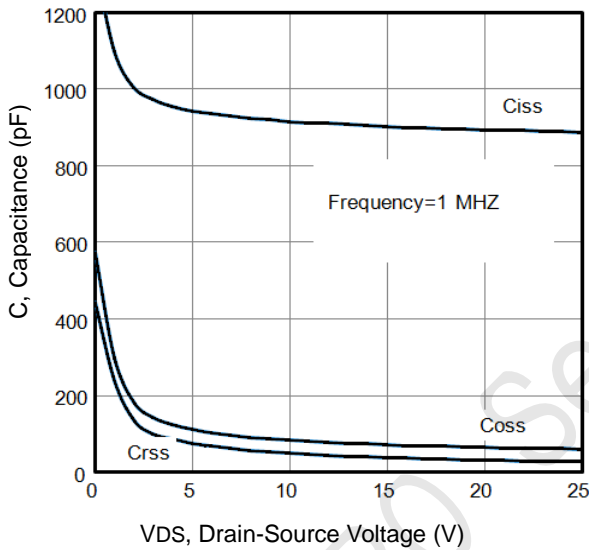
**Typical Characteristics:** (Tc=25°C unless otherwise noted)

**Fig1.** Typical Output Characteristics

**Fig2.** VGS(TH) Voltage Vs. Temperature

**Fig3.** Typical Transfer Characteristics

**Fig4.** On-Resistance vs. Drain Current and Gate Voltage



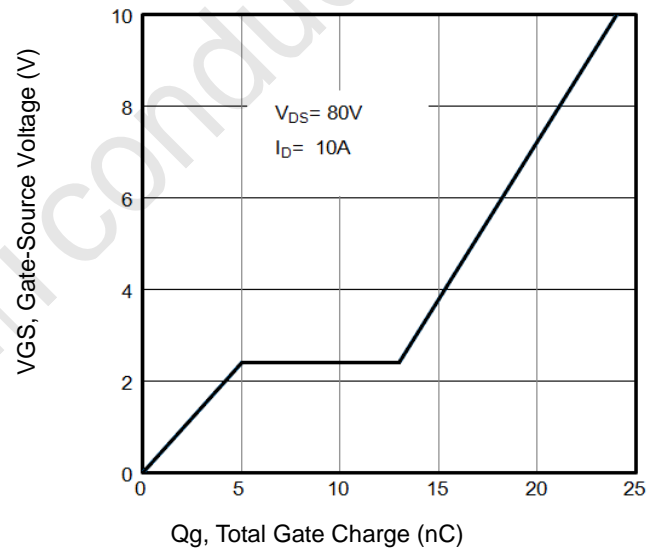
**Fig5.** Typical Source-Drain Diode Forward Voltage



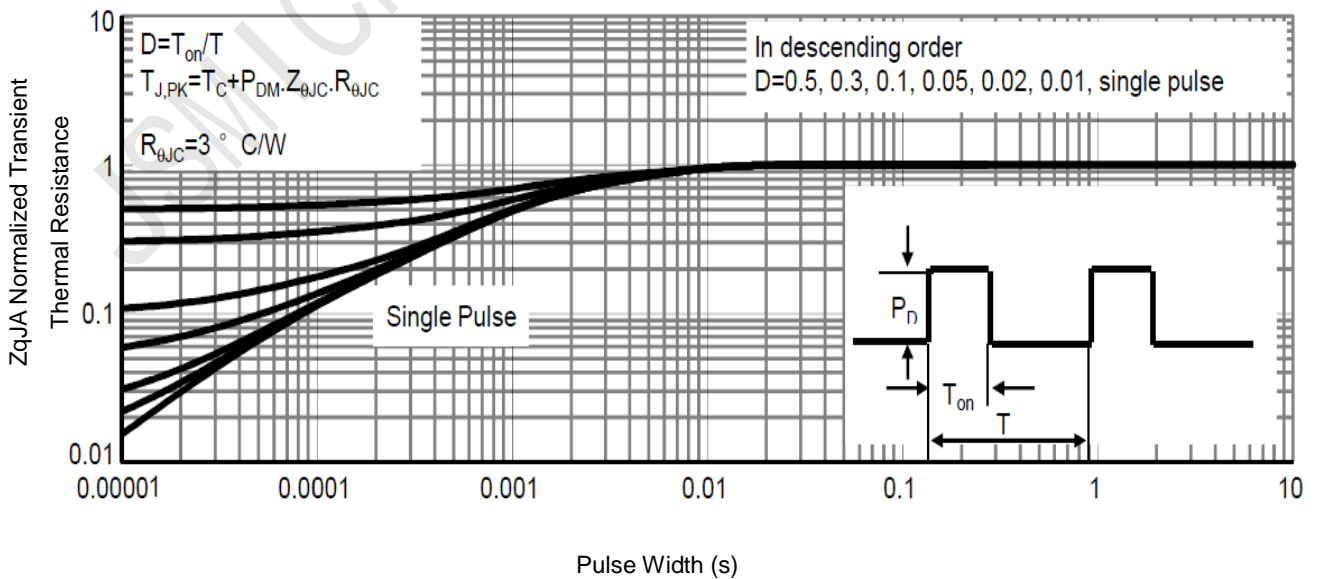
**Fig6.** Maximum Safe Operating Area



**Fig7.** Typical Capacitance Vs. Drain-Source Voltage

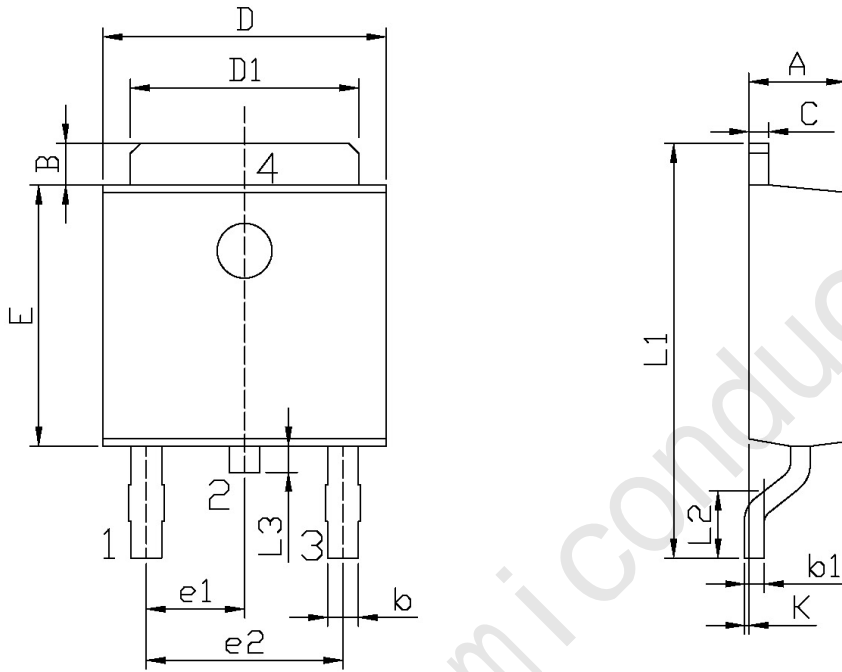


**Fig8.** Typical Gate Charge Vs. Gate-Source Voltage



**Fig9.** Normalized Maximum Transient Thermal Impedance

外形尺寸图 / Package Dimensions



单位: mm

Symbol	Dimensions In Millimeters		Symbol	Dimensions In Millimeters	
	Min	Max		Min	Max
A	2.20	2.40	E	5.95	6.25
B	0.95	1.25	e1	2.24	2.34
b	0.50	0.70	e2	4.43	4.73
b1	0.45	0.55	L1	9.45	9.95
C	0.45	0.55	L2	1.25	1.75
D	6.45	6.75	L3	0.60	0.90
D1	5.10	5.50	K	0.00	0.10

TO-252